

ECHOSPEX™ Wall L & S – Product Detail Sheet

Date: 6/11/2020

NAME: ECHOSPEX™ Wall L & Wall S

DESIGNER: Cuts By Design

ORIGIN: Australia (EchoPanel®) UK (Perspex®) Finished Product = Australia

COLOURS: EchoPanel® Mushroom 454
 EchoPanel® Pebble 402
 EchoPanel® Vanilla 468
 EchoPanel® Cream 908
 EchoPanel® Onyx 550
 EchoPanel® Grey 442
 EchoPanel® Charcoal 542

EchoPanel® Mushroom 454 with PERSPEX® Platinum 9py2
 EchoPanel® Pebble 402 with PERSPEX® Platinum 9py2
 EchoPanel® Vanilla 468 with PERSPEX® Caramel Gold 5PY0
 EchoPanel® Cream 908 with PERSPEX® Pearl 1PY1
 EchoPanel® Onyx 550 with PERSPEX® White 1212
 EchoPanel® Grey 442 with PERSPEX® Mist Grey 9981
 EchoPanel® Charcoal 542 with PERSPEX® Midnight Black S2 9221

COMPOSITION: EchoPanel® 100% PET (60% recycled)
 PERSPEX® Cast acrylic

PANEL DIMENSIONS: 598 x 598 / 598 x 1198mm (+/- 2mm)

WALL S

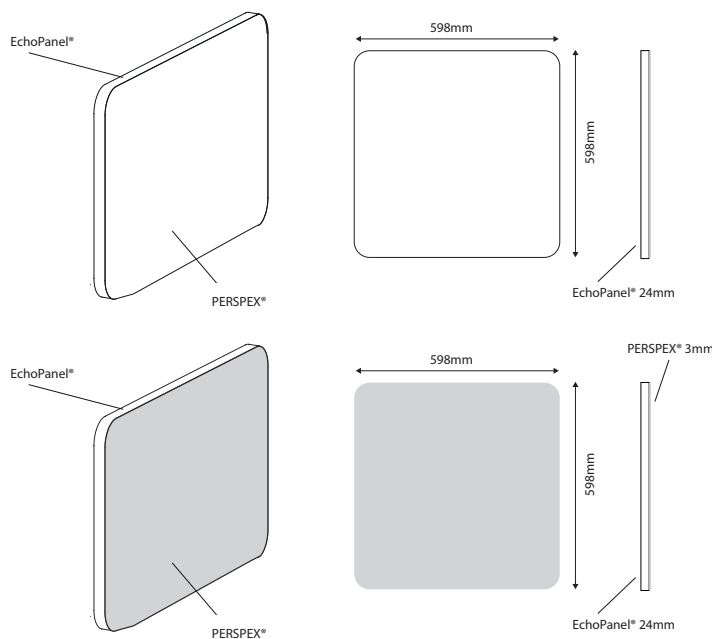

WALL L

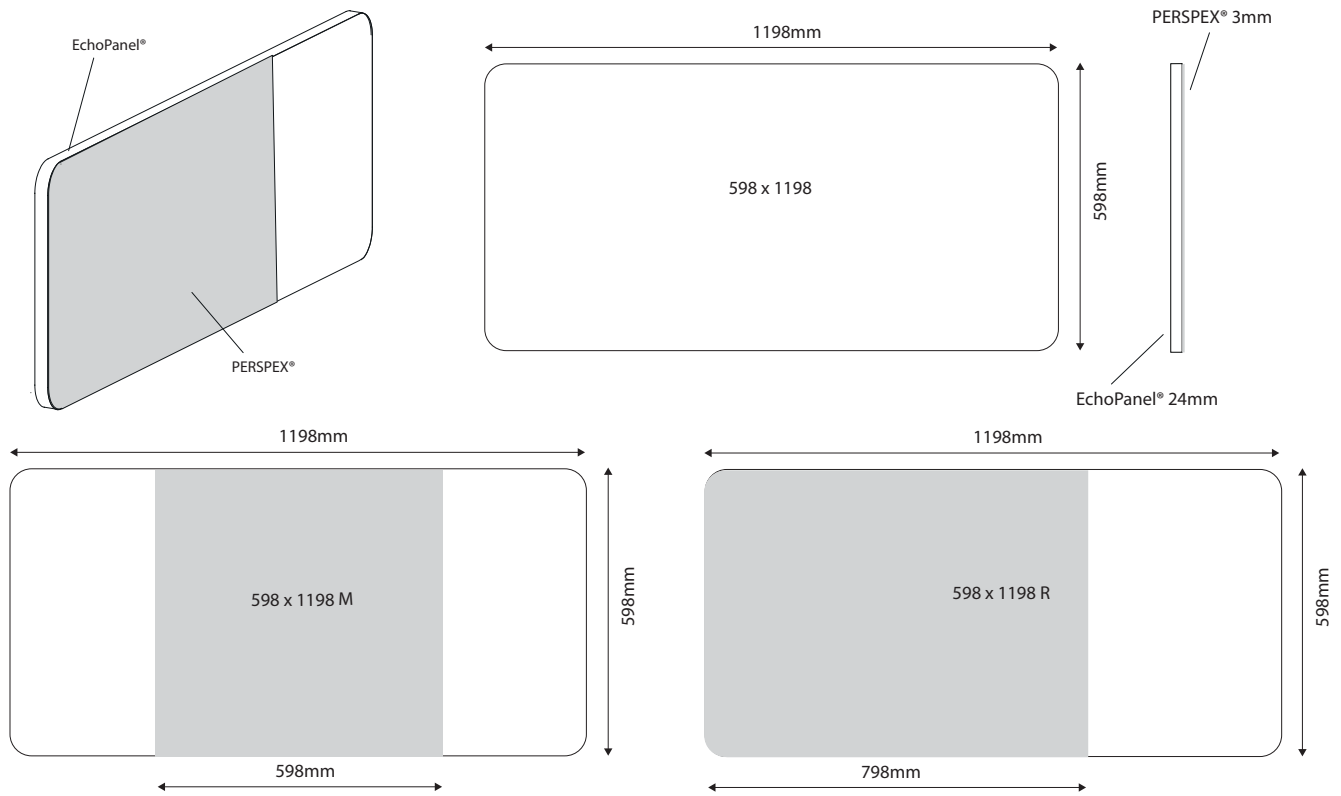

WALL L (OPTIONAL PEN TRAY)

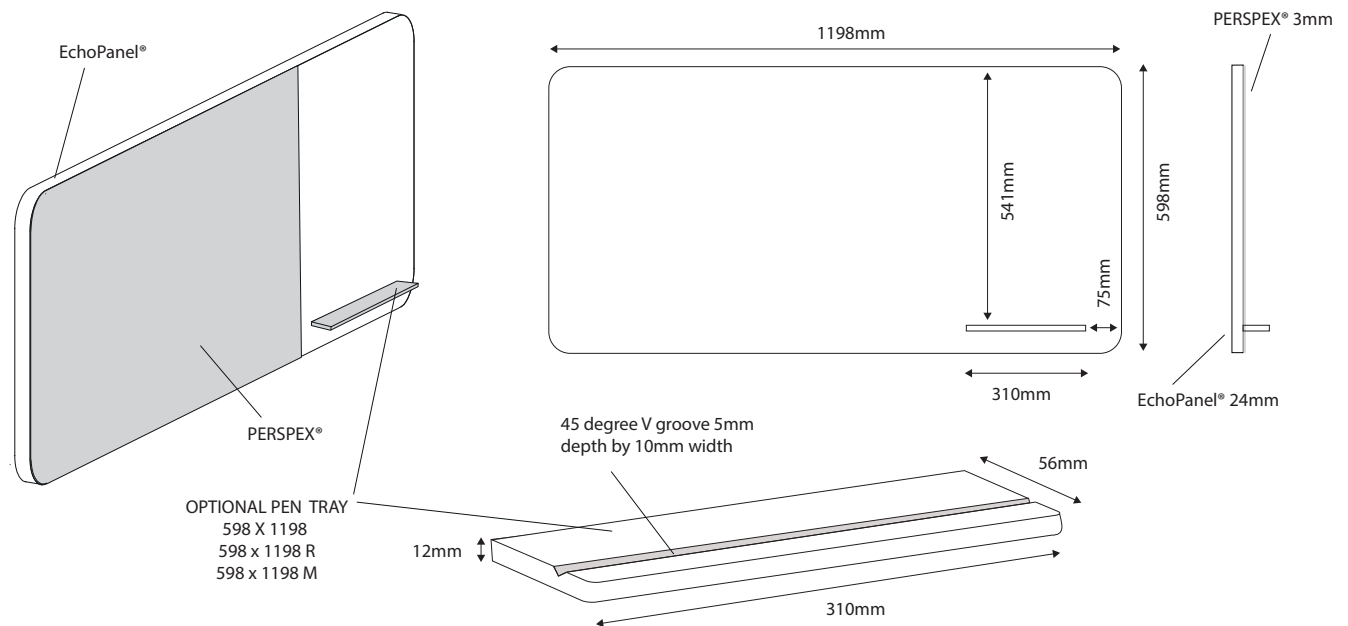

WEIGHT: 6,500g/m2 +/- 10%

THICKNESS: 24mm +/- 7% (EchoPanel®)
 27mm +/- 7% (EchoPanel® with PERSPEX®)

PERFORMANCE ECHOPANEL® 24MM

COLOUR FASTNESS TO LIGHT: ISO 105-B02-1994 Rating: 6-7

FIRE TEST: ISO 9705: Group 1

ASTM E84Unadhered: B or Class 2

BS EN 13501.1: Classification B-s1, d0

EchoPanel® CARE: Blot excess spills from material quickly. Wipe with a damp cloth. If stain persists, apply small quantities of carpet or upholstery shampoo solution with a damp cloth. Blot well with a clean cloth after each application of the solution. Warning, avoid excessive amounts of water. Ensure adequate ventilation if the product is likely to be subject to excessive moisture.

SOUND ABSORPTION: AS ISO 354 – 2006
NRC Value: 0.65 (with no air gap)
NRC Value: 0.75 (with 20mm air gap)
NRC Value: 0.85 (with 50mm air gap)

FLEXURAL PROPERTIES: ISO 1209-1-2007 @20mm Deflection

VOC EMISSIONS: ASTM D5116 Rate: < 0.02 mg/m²/hr (7 days)



ENVIRONMENTAL: EchoPanel® achieves GreenTag Certification GreenRate: Level A



PERFORMANCE PERSPEX® 3MM

COLOURS:	10 YEARS WARRANTY *Colours Platinum 9PY2, Caramel Gold 5PY0 & Pearl 1PY1, contain metallics and are designed to react to a light source resulting in a shaded effect. Depending on the light source this effect can appear irregular.
FIRE TEST:	AS/NZS 1530.3 Group 4
ROCKWELL HARDNESS:	ISO 2039-2 (M scale / 102)
WHITEBOARD USE:	Perspex® whiteboard approved. Use only approved white board markers or water based paint pens.

PERSPEX® CARE: PERSPEX® acrylic sheet has very good chemical resistance and the high gloss surface is highly non-porous so shouldn't have a problem when written on with non-permanent markers. In normal use, a simple wipe with a dry cloth or white board cleaner will be fine to remove anything left on the board. From time to time, it is perfectly acceptable to use a soft cloth wetted-out with a small quantity of methylated spirits to remove any stubborn, long term stains. The high chemical resistance of PERSPEX® means that there is no risk of damage to the board (as long as this type of solvent clean doesn't become a regular, repeated activity).

FLEXURAL PROPERTIES:	ISO 178 (2mm/min) MPa 116
TOXIC PROPERTIES:	Non toxic, lead free, BPA free, ROHS complainant, Food grade safe.



COLOURS ECHOPANEL®



Mushroom 454



Pebble 402



Cream 908



Vanilla 468

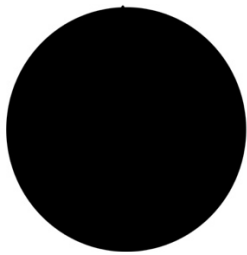

Onyx 550



Grey 442



Charcoal 542

COLOURS ECHOPANEL® & PERSPEX®



Mushroom 454
Platinum 9py2*

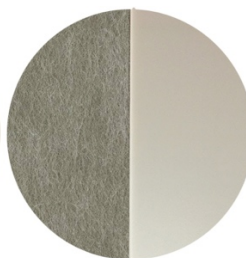

Pebble 402
Platinum 9py2*



Cream 908
Pearl 1PY1*

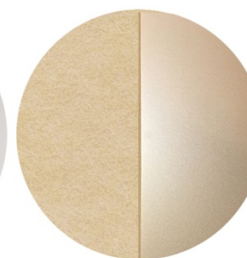

Vanilla 468
Caramel Gold 5PY0*



Onyx 550
White 1212

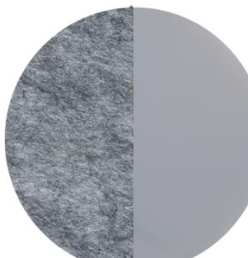

Grey 442
Mist Grey 8891

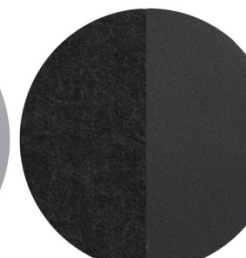

Charcoal 542
Midnight Black S2 9221

Colours shown are a guide only, final decisions should be made directly from actual samples.

*Please note PERSPEX® colours Platinum 9py2, Caramel Gold 5py0 & Pearl 1PY, contain metallics and are designed to react to a light source resulting in a shaded effect. Depending on the light source this effect can appear irregular.